



USER GUIDE

Table of contents

Important safety instructions	2
About this manual	3
Meet MODIO	3
What's in the kit?	3
What else do you need?	3
Install MODIO	4
Mount to back of TV	4
Mount to furniture	5
Mount to wall	5
Connect the control pad	6
Connect the power supply	6
Select the masking curve	6
Custom curve	6
Standard curve	6
Set the masking level	7
Adjust the level	7
Set the default level	7
Restore the default level	7
Add MODIO to the guest directory	7
Provide guest instructions	8
Get technical support	8
Maintenance	8
Warranty	8
Tech specs	9-10
Mechanical drawings	11

Important safety instructions

1. Read these instructions.
2. Keep these instructions.
3. Heed all warnings.
4. Follow all instructions.
5. Do not use this apparatus near water.
6. Clean only with dry cloth.
7. Do not block any ventilation openings. Install in accordance with the manufacturer's instructions.
8. Do not install near any heat sources such as radiators, heat registers, stoves, or other apparatus (including amplifiers) that produce heat.
9. Do not defeat the safety purpose of the polarized or grounding-type plug. A polarized plug has two blades, one wider than the other. A grounding type plug has two blades and a third grounding prong. The wide blade of the third prong is provided for your safety. If the provided plug does not fit into your outlet, consult an electrician for replacement of the obsolete outlet.
10. Protect the power cord from being walked on or pinched, particularly at plugs, convenience receptacles, and the point where they exit from the apparatus.
11. Only use attachments / accessories specified by the manufacturer.
12. Refer all servicing to qualified service personnel. Servicing is required when the apparatus has been damaged in any way, such as if a power-supply cord or plug is damaged, liquid has been spilled or objects have fallen into the apparatus, the apparatus has been exposed to rain or moisture, does not operate normally, or has been dropped.

CAUTION: These servicing instructions are for use by qualified service personnel only. To reduce the risk of electric shock, do not perform any servicing other than that contained in the operating instructions unless you are qualified to do so.

WARNING: To reduce the risk of fire or electric shock, do not expose this apparatus to rain or moisture. Apparatus shall not be exposed to dripping or splashing and no objects filled with liquids, such as vases, shall be placed on the apparatus.

About this manual

This manual is intended for individuals who are installing and /or using MODIO. It provides an overview of the kit components, required tools and installation procedures, as well as technical support and maintenance information. It also provides operational instructions for hotel staff and guests.

IMPORTANT: K.R. Moeller Associates Ltd. (the 'MODIO manufacturer') does not assume any responsibility or liability for the information given and shall not be liable for any direct, indirect, special, incidental or consequential damages in connection with the use of this information. The information in this manual is subject to change without notice.

Meet MODIO

MODIO introduces a continuous soothing background sound into the room, allowing guests to control its acoustic ambience as they would temperature and lighting. The sound is similar to soft airflow, designed for comfort and engineered to cover a variety of hotel noises.

MODIO quickly mounts to the back of any flat screen TV using standard VESA brackets. The device can also be placed beneath or behind furnishings, or attached to a wall.

Much like a dimmer switch, a control pad allows each guest to set the background sound level according to personal preference or as needed to cover disturbances. Instructions on the bottom of the control pad quickly tell guests about the purpose and use of this amenity.

One MODIO covers a typical single guest room.

What's in the kit?

- MODIO
- Control Pad
- Power Supply
- Power Coupler
- Main Bracket
- 2 x Extension Brackets
- Mounting Hardware
 - 3 x screws (8-32 x 3/8 in.)
 - 3 x sets of 2 bolts (M4, M6, M8)
 - 4 x cap nuts (8-32)
 - 4 x screws (8-32 x 3/8 in.)

What else do you need?

You need the following tool:

- Phillips screwdriver

Depending on where you plan to install MODIO, you might also need:

- Adjustable wrench or 11/32-inch hex wrench, if the VESA mount is 40 cm or larger
- Power cord, if using a non-North American plug
- Screws, if attaching MODIO to a piece of furniture
- Screws and anchors, if attaching MODIO to a wall
- A 3.5 mm 4-pole headphone cable extender, if you intend to place the control pad more than 1.8 meters (6 feet) away from MODIO
- Cable ties, if you plan to install MODIO in a location where the cables are visible

Install MODIO

The MODIO manufacturer recommends using UL-Listed or equivalent materials during installation. All installation methods must comply with all locally applicable building code requirements.

Mount to back of TV

If the TV is standing on a furnishing, you can install MODIO directly on the back of the TV using the standard VESA mounts.

The minimum recommended space behind the TV is 15 cm (6 inches). Tighter spacing can be accommodated, providing the masking curve is customized by a MODIO representative.

1. Verify the TV's VESA mount dimensions (10 cm, 20 cm or 40 cm).
2. Select the appropriate bracket(s) and mounting hardware from the kit:

VESA Mount Dimensions	MODIO Bracket & Mounting Holes	MODIO Hardware	MODIO Bolts
10* cm	Main Bracket Use inner holes	3 screws + 2 bolts	M4
20* cm	Main Bracket Use outer holes	3 screws + 2 bolts	M6
40* cm	Main Bracket + Extension Brackets Use extension bracket holes	3 screws + 2 bolts + 4 cap nuts & 4 screws	M6 or M8

3. Place MODIO grill side down on a soft surface.
4. Place the main bracket on the back of MODIO, with the three recessed mounting holes facing towards you and aligned with the three small circular holes on the back of MODIO.
5. Using a Phillips screwdriver, attach the main bracket to the back of MODIO with the three screws.

NOTE: If the TV features a 40 cm VESA mount, before performing the above step, attach an extension bracket to each side of the main bracket. To do so, align the extension bracket's holes with those on the side of the main bracket, oriented so that the surface of the completed bracket is flat on the TV-mounting side. Insert the screws into the TV-mounting side and thread the nut onto the screw on the opposite side. Use a Philips screwdriver to hold each screw steady while you tighten the nut with an adjustable wrench or 11/32-inch hex wrench. Each extension bracket uses two screws and two nuts.
6. Align the main bracket holes with the VESA mounts on the TV and insert the two bolts.

NOTE: If the TV features a 40 cm VESA mount, align the extension brackets' holes with the VESA mounts on the TV and insert the two bolts.
7. Using a Phillips screwdriver, tighten the bolts. Do not overtighten.
8. Verify that MODIO is sitting flat against the back of the TV. If not, contact a MODIO representative. Also verify that the device is not substantially blocking the TV ventilation. If so, use one of the other installation options.

Install MODIO (continued)

Mount to furniture

To mount MODIO to an item of furniture (e.g. beneath a desk or table), contact your MODIO representative to request a specialized bracket.

1. Determine the location where you want to install MODIO.

NOTE: The ideal location is close to a power source, allows the cables to be hidden and the masking sound to disperse into the bed area.

2. Using the specialized bracket as a template, mark the screw locations on the furniture.
3. Place MODIO grill side down on a soft surface.
4. Place the bracket on the back of MODIO, with the three recessed mounting holes facing towards you and aligned with the three small circular holes on the back of MODIO.
5. Using a Phillips screwdriver, attach the bracket to the back of MODIO with the three screws.
6. Use screws (not included) to attach MODIO to the desired furnishing.

Mount to wall

1. Determine the location where you want to install MODIO.

NOTE: The ideal location is close to a power source, allows the control pad to be placed on an item of furniture, the cables to be hidden, and the masking sound to disperse into the bed area. For example, in a room with a wall-mounted TV, MODIO can be installed just above the TV with the cables running behind it, down to the power source. The control pad can be placed on a furnishing beneath the TV.

2. Using the main bracket as a template, mark the locations for the screws on the wall.
3. Place MODIO grill side down on a soft surface.
4. Place the main bracket on the back of MODIO, with the three recessed mounting holes facing towards you and aligned with the three small circular holes on the back of MODIO.
5. Using a Phillips screwdriver, attach the main bracket to the back of MODIO with the three screws.
6. Use wall anchors and screws (not included) to attach MODIO to the desired location on the wall.

Connect the control pad

The control pad has a standard 1.8 m (6 foot) cable. If a longer distance is required between MODIO and the control pad, purchase a 3.5 mm 4-pole headphone cable extender.

1. Insert the plug at the end of the control pad cable into the jack on MODIO.
2. Place the control pad in a suitable location.

NOTE: If needed, bundle or arrange the cables using cable ties (not included).

Connect the power supply

If you are located in a region using non-North American plugs, purchase the required power cord.

1. Insert the power coupler into the 6-pin connector on MODIO, ensuring the locking mechanism (i.e. the small tab below the six pins) goes into the rectangular opening beneath the 6-pin connector.
2. Insert the barrel plug at the end of the power supply cord into the power coupler.

NOTE: If you have purchased a power cord with a non-North American plug, plug the female end into power supply.

3. Plug the power supply into an appropriate electrical outlet.

NOTE: To remove the power coupler, use your fingernail or a small screwdriver to press the locking mechanism (i.e. the small tab below the six pins) against the coupler and pull the coupler out. Attempting to remove the coupler without releasing the locking mechanism will damage the device.

Select the masking curve

MODIO offers options for frequency adjustment:

Custom curve

The MODIO manufacturer recommends customizing the curve to each guest room using specialized software and a sound analyzer—a service offered by MODIO representatives.

Standard curve

In cases where the above option is not feasible, MODIO comes with a pre-set curve engineered for open guestroom installations.

For more information about these options, contact a MODIO representative.

Set the masking level

Adjust the level

A range of volume adjustment is available to the guest, from 'OFF' (29 dBA) to '10' (58 dBA) on the control pad (measured at 1 meter (3.3 feet) from MODIO). If a higher or lower default volume is desired, contact a MODIO representative.

Set the default level

MODIO comes with a factory-default volume range of 29-58 dBA. If you set the control pad dial to the '3' position, the device produces 53 dBA at 1 meter (3.3 feet), which typically translates to the low to mid-40s in the bed area. If you want to establish a different volume range and default level for your rooms, contact a MODIO representative.

Restore the default level

When a guest enters their room, MODIO should be operating at the default level. During their stay, the guest might adjust the level according to personal preference or need. After they depart, housekeeping staff should restore MODIO to the default level. To do so, simply turn the control pad dial so that its arrow aligns with the default setting (between 1 and 10) you have established.

Add MODIO to the guest directory

If you would like to include information about MODIO in your guest directory, we suggest the following:

MODIO™ GUESTROOM ACOUSTIC CONTROL

We want you to have a relaxing stay and a good night's sleep.

MODIO introduces a continuous soothing background sound into your room, allowing you to control its acoustic ambience as you would temperature and lighting. The sound is similar to soft airflow, designed for comfort and specifically engineered to cover a wide variety of noises.

Unlike 'white noise' machines or apps, MODIO is a commercial-grade device designed by the manufacturer of the LogiSon Acoustic Network—a company with over 40 years' experience in the sound masking field. Their award-winning products have been installed in hundreds of millions of square feet worldwide, including offices, banks, call centers, hospitals and more.

MODIO is mounted to [location] in order to disperse the masking sound within your bed area. To adjust the level, simply turn the dial on the control pad to a position between OFF and 10. To restore MODIO to its default level, turn the dial to [default setting] on the pad.

Provide guest instructions

The following instructions are printed on the bottom of the control pad. You can also add a description to your guest directory, as noted in the previous section.

MODIO introduces a continuous soothing background sound into your room, allowing you to control its acoustic ambience as you would temperature and lighting. To set the volume to your desired level, simply turn the dial to a position between OFF and 10.

Get technical support

If MODIO is not making any sound, take the following steps in sequence:

1. Ensure the control pad is connected.
2. Ensure the control pad dial is not set to OFF.
3. Check the power supply connection at the device and electrical outlet.
4. Ensure the electrical outlet has power (i.e. check if other devices connected to it have power).
5. Try another MODIO power supply.
6. Contact a MODIO representative or the manufacturer by emailing techsupport@modio.audio or calling 905-332-1730, ext. 57 (9 am to 5 pm, Eastern Time).

Maintenance

IMPORTANT: Before you connect or disconnect any components, always disconnect the power supply.

The manufacturer strongly recommends maintaining a small inventory of extra components, including MODIO, control pads and power supplies, in order to efficiently provide service to guests. You can also order replacement parts from your MODIO supplier.

NOTE: Screws, nuts and bolts meeting the MODIO specs can also be sourced from a hardware supplier.

Warranty

For warranty information, see the related sections of the tech specs table on following page. To request warranty-related assistance, contact the supplier from whom you purchased MODIO.

Tech specs

MODIO

Masking Performance

Sound Generation	Digital Signal Processor (DSP), truly random (nondeterministic)
Volume	29 to 58 dBA @ 1 m (3.3 ft) at factory default settings; 85 dBA maximum
Equalization	1/3-octave, 23 bands, 63 to 10,000 Hz

Connections

Power/Network Input	6-pin
Control Input	3.5 mm 4-pole stereo jack

Power

Input	24 VDC
Consumption	3.4 W at typical settings

Physical Specifications

Dimensions (W x H x D)	148 x 232 x 88 mm (5.8 x 9.1 x 3.5 inches)
Weight	2.3 lbs (1 kg)
Mounting	Flexible mounting options; see Modio User Guide
Certifications	Meets UL, CE, ACMA (C-Tick), KC and FCC standards; RoHS compliant
Warranty	5 years

CONTROL PAD

Dimensions (W x H x D)	66 x 52 x 95 mm (2.6 x 2.0 x 3.7 inches)
Weight	0.3 lbs (146 g)
Connection	3.5 mm 4-pole stereo plug
Warranty	1 year

POWER SUPPLY (MODEL SWI18-24-N)

Electrical Performance

Input Voltage	Min 90 VAC; Max 264 VAC
Input Frequency	Min 47 Hz; Max 63 Hz
Output Voltage	24 VDC
Output Power Range	Max 18 W

Connections

Output Connector	Barrel plug, 2.1 mm I.D. x 5.5 mm O.D. x 9.5 mm
Input Connector	NEMA 1-15P
Operating Temperature	0°C - 40°C

Physical Specifications

Dimensions (W x H x D)	72 x 34 x 52 mm (2.8 x 1.3 x 2.0 inches)
Weight	0.375 lbs (170.1 g)
Cord Length	1.5 m (59 inches)

Certifications

Safety Standards	UL/cUL, PSE
EMC	FCC Part 15B Class B
RoHS	RoHS compliant
Countries	USA, Canada, Mexico, and Japan, as well as other countries accepting these certifications and NEMA 1-15P.
Manufacturer Warranty	1 year

Tech specs (continued)

POWER SUPPLY
(MODEL GST25A24)
* POWER CORD
NOT INCLUDED

Electrical Performance

Input Voltage	Min 85 VAC; Max 264 VAC
Input Frequency	Min 47 Hz; Max 63 Hz
Output Voltage	24 VDC
Output Power Range	Max 25 W

Connections

Output Connector	Barrel plug, 2.1 mm I.D. x 5.5 mm O.D. x 11 mm
Input Connector	IEC320-C14 AC Inlet
Operating Temperature	-30°C - 70°C

Physical Specifications

Dimensions	54 x 36 x 93 mm (2.1 x 1.4 x 3.7 inches)
Weight	0.48 lbs (219 g)

Certifications

Safety Standards	UL60950-1, CSA C22.2, TUV EN60950-1, BSMI CNS14336, CCC GB4943, PSE J60950-1, AS/NZS 60950.1, BIS IS13252, KC K60950-1, EAC TP TC 004 approved; SIRIM MS IEC60950-1 (optional) approved
EMC	Compliance to EN55032(CISPR32) class B, EN61000-3-2,3, FCC PART 15 / CISPR22 class B, CAN ICES-3(B)/NMB-3(B), CNS13438 class B, GB9254, GB17625.1, EAC TP TC 020, MSIP KN32
RoHS	RoHS compliant
Countries	For use in Europe, India, China, Australia, New Zealand, Russia, and more; request a complete list from the MODIO manufacturer.
Manufacturer Warranty	3 years

NOTE: Technical specifications are subject to change without notice.

Mechanical drawings

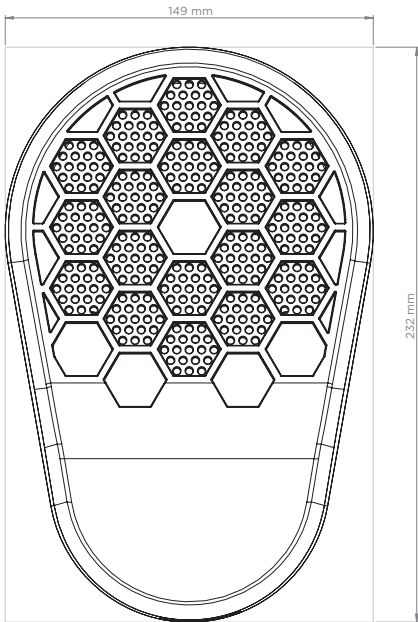

MODIO (FRONT)

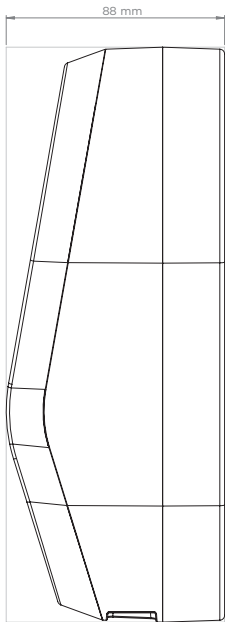

MODIO (SIDE)

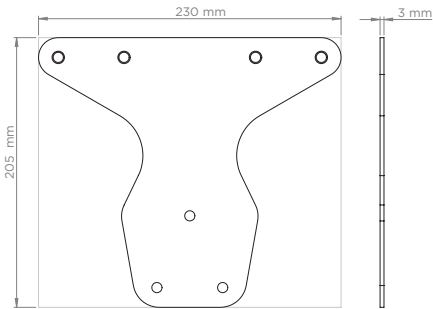

MAIN BRACKET

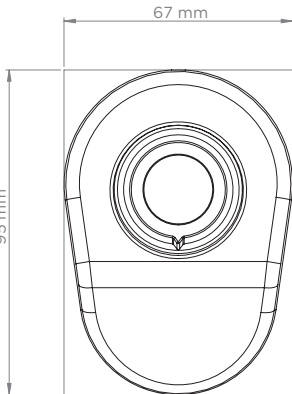

CONTROL PAD (TOP)

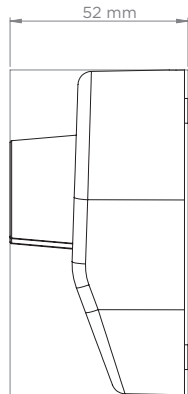

CONTROL PAD (SIDE)

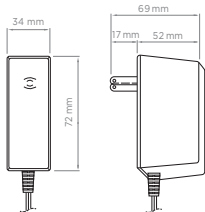

POWER SUPPLY (MODEL SW118-24-N)

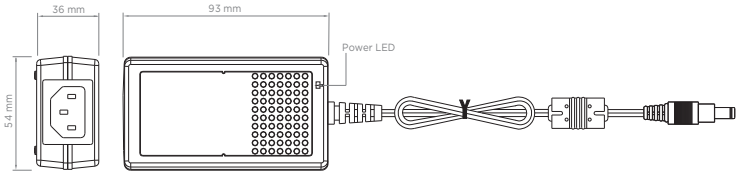

POWER SUPPLY (MODEL GST25A24)



MODIO
By LogiSon
GUESTROOM ACOUSTIC CONTROL